

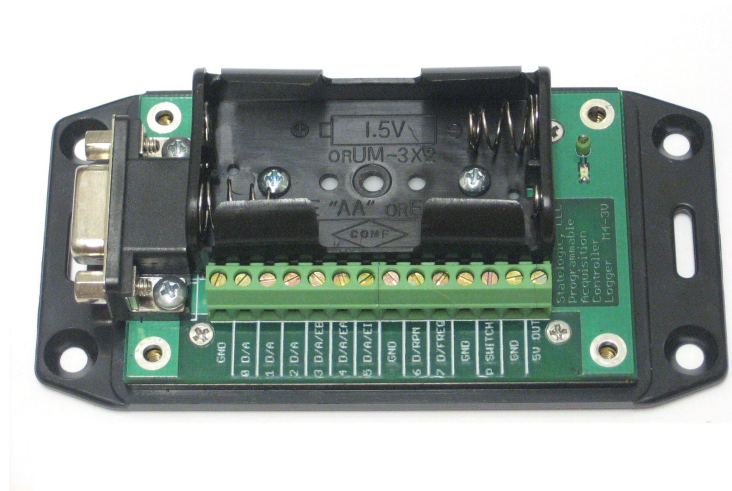

Programmable Acquisition Logger Controller



PALC M4-3V Operation Manual

Version 1.1.41
Revision 0
February 15, 2010

Table of Contents

1 Overview.....	3
Features.....	3
Hardware Configuration.....	4
Host requirements:.....	4
Channel Configuration Table.....	4
PALC M43V Diagram.....	5
2 Quick Start.....	6
Run.....	6
Log Data.....	8
Controller.....	9
3 Command Reference.....	10
Fast Code.....	10
Show Commands.....	11
Configurations and Status.....	11
Set Commands.....	11
Channels.....	11
Channels 0 to 5 A/D Configuration Sub-Menu.....	12
Channel 3, 4, 5 Encoder Configuration Sub-Menu.....	12
Encoder External Index Timing Diagrams.....	13
Channel 6 RPM Configuration Sub-Menu.....	15
Channel 7 Counter Configuration Sub-Menu.....	15
Timing Functions.....	16
Trigger Modes.....	17
Trigger Modes Timing Diagrams.....	18
Print Formatting.....	20
Data Logging.....	21
Controllers.....	21
Operate Commands.....	22
Output.....	22
Run.....	22
Trigger.....	23
Zero.....	23
4 Configuration Notes.....	24
Automatic Reconfiguration of Inputs.....	24
Controller Setup Tips.....	24
Using RPM for Fast Sample Rates.....	24
Input Noise.....	24
Battery Types.....	25
5 Specifications.....	26
Sleep States.....	26
Electrical.....	26
6 Warranty.....	28

1 Overview

Features

1. Six channels configurable as 10-bit A/D conversion or digital logic I/O.
2. Quadrature encoder interface for angle and direction of optical or mechanical encoders
3. One channel for RPM speed measurement or digital logic I/O.
4. One channel for frequency counting, event counting, or digital I/O.
5. One high power MOSFET relay can switch 30 volt DC loads of up to 2.0 amps, protected against inductive loads such as relays and small motors.
6. Precision 5.12 Volt reference can supply power to external sensors, switches, or indicators.
7. Acquisition rates up to 10 times per second to once every 10 minutes and 59 seconds.
8. Three acquisition trigger modes: internal time base, external event trigger, or by serial link command.
9. Scheduled runs from once every 2 minutes to once every 24 hours.
10. Outputs may be controlled through the serial link.
11. Functions as a stand-alone controller. Six independent on/off controllers compare inputs to user set-points and control digital outputs and the power switch.
12. 65 thousand samples data logging memory.
13. Configuration settings are permanently saved in non-volatile EEPROM.
14. Configuration syntax is in English. Interface menu displays choices. Command typing is auto-completed. Manual look-up or memorization of command syntax is unnecessary.
15. Interface mode to assist host-controlled automated software data acquisition.
16. RS-232 serial interface communicates with most serial terminal software and hardware. No proprietary software to install. No operating system requirement. Open communication protocol.
17. Low power operation - up to 1 month continuous operation on AA batteries while in converting and sending data to a host computer.
18. LED provides visual indication of sampling operation.
19. Automatic sleep mode. Wake-up on serial port activity.
20. Terminals are protected against static discharge and up to +/- 200 mA over-current.

Hardware Configuration

Host requirements:

Host computer system with a standard RS-232 serial port.

Serial port terminal software usually included with many operating systems is sufficient:

- MS-Windows® - HyperTerminal®, RealTerm, etc.
- LINUX® - minicom, seyon, etc.

Channel Configuration Table

Channel	Configurable As							
	10 bit A/D	RPM Input	Frequency Input	Pulse Counter	External Trigger	Encoder Input	Digital Input	Digital Output
0	yes						ST	CMOS
1	yes						ST	CMOS
2	yes						TTL	CMOS
3	yes					A	TTL	CMOS
4	yes					B	TTL	CMOS
5	yes					Index	TTL	CMOS
6		yes			yes		ST	CMOS
7			yes	yes			ST	CMOS
Power Switch								Open Drain

PALC M4-3V Diagram

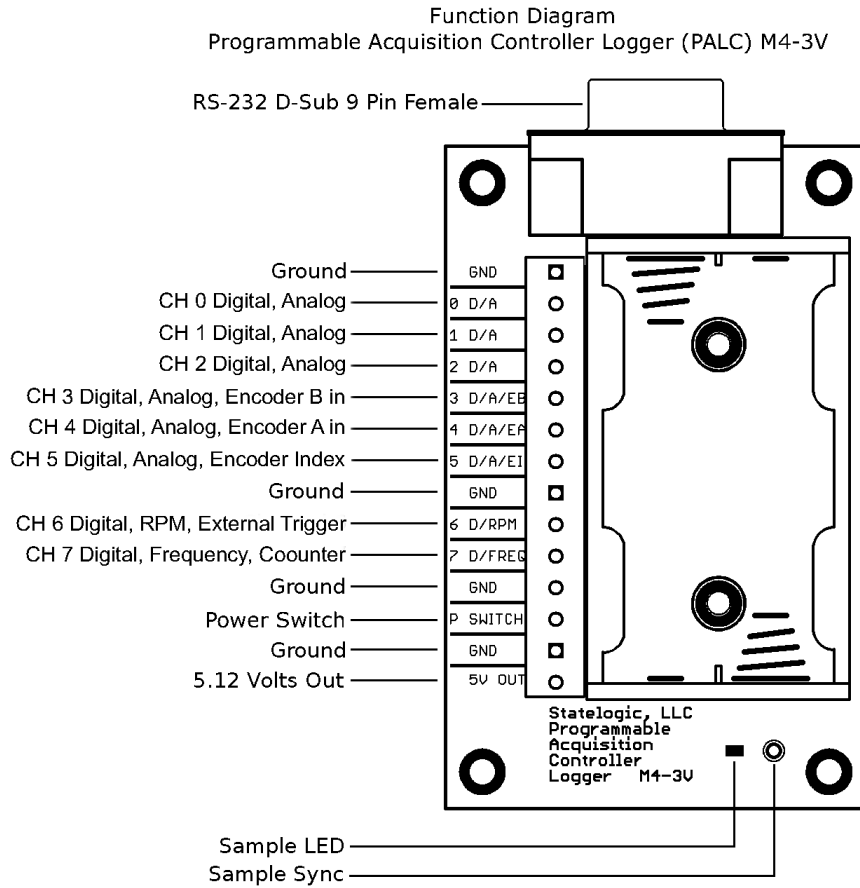

Figure 1: Connection Diagram

2 Quick Start

Run

Configure your serial port terminal program for

- 57,600 baud
- one stop bit
- no parity bit
- no handshaking

PALC transmits CR-LF as line terminator and accepts LF, CR or CR-LF as terminator.

Install 2 size AA batteries. Connect to the host computer using a standard serial port cable. Do not use a "null-modem" cable. You should now be able to communicate with PALC. Type any key to wake up PALC, then tap the space-bar and a menu should appear:

```
> [run] [output] [set] [show] [trigger] [zero]
> _
```

PALC automatically completes command typing. In the following examples below the underlined characters indicate the manually typed portion. The remainder of the command syntax is automatically completed and displayed by the PALC.

Type "setri", and [ENTER].

```
> set trigger source internal timebase
```

Type "rn", and [ENTER].

```
> run now [ENTER]

Trigger source: internal timebase
HH:MM:SS.d  A-In  A-In  A-In  A-In  A-In  A-In  RPM  FREQ
00:00:00.0   95   12   36   201   181    62    0    0
00:00:01.0   99   20   53   288   122   103    0    0
00:00:02.0   87   33   57   334    95   138    0    0
```

Type "s" [ENTER] to stop sampling. During [run] there is only one menu option: [stop].

```
00:00:03.0    76    50    57   363    80   169    0    0
stop [ENTER]

>_
```

Type "show status"

```
>show status [ENTER]

STATELOGIC LLC Programmable/Acquisition/Logger/Controller M4-3V
V1.1.41

Time
Clock.....00:00:27
Scheduled run
Start.....00:00 --
Duration.....00:00 -- no duration
Repeat.....00:00 -- no repeat
Sample rate..... 1 Hz
Sleep delay..... 10 sec
Index.....000004
Trigger
Source..... internal timebase
Burst samples..... 1
Print
Index..... clock time
Header..... on
Scrolling..... on
Logger
Mode..... restart data [DISABLED]
Memory reserve.....65472 of 65472 samples
Battery..... 2.90 Volts

>
```

Log Data

Type “shst” [ENTER] to show status of data logging. Data logging may be enabled or disabled and has the following two modes:

1. Restart: each time a run command is issued, logging will start at the beginning of memory. All data from a previous run session will be lost.
2. Append: each time a run command is issued logging will resume in memory appended to the last data recorded. Header information will separate the run sessions upon memory dump. Data logging will cease when the memory is full, however data sampling operation will continue.

Data Logging example

```
>set logger mode append data [ENTER]

>set logger enable [ENTER]

>run now [ENTER]

Trigger source: internal timebase
HH:MM:SS.d  A-In  A-In  A-In  A-In  A-In  A-In  RPM  FREQ

00:01:26.0   54   15   31   240   73   74    0    0
00:01:27.0   54   34   43   315   62  121    0    0
00:01:28.0   53   52   46   346   61  155    0    0
stop [ENTER]

>show logger data [ENTER]

Trigger source: internal timebase
HH:MM:SS.d  A-In  A-In  A-In  A-In  A-In  A-In  RPM  FREQ

00:01:26.0   54   15   31   240   73   74    0    0
00:01:27.0   54   34   43   315   62  121    0    0
00:01:28.0   53   52   46   346   61  155    0    0
```

Controller

Six independent controllers with user defined set-points may be configured to monitor any Analog, RPM, Count, Frequency, or Encoder input. Each controller performs the comparison test \geq or $<$ between the input and the set-point, and controls an output based on the true/false result. Configuring a controller is as easy as filling in the following sentence:

“For input X greater-than-equal / less-than the value Y sets output Z high / low latches /resets”

Description

- output resets: For an output changed by a true input condition, if the input condition is removed the output resets to the original state.
- output latches: For an output changed by a true input condition, the output will remain changed permanently. The output state may be reversed by another set-point which also controls the output, except to reverse the output state. The output may also be changed by an “output” command via serial control.

The controller configuration dialog:

```
>set controller config (0 to 5) [ENTER]

For input (0 to 7) is [GE] [LT] [ENTER]

The value 1 - 65535: (enter value) [ENTER]

sets output (0 to 7) | [high] [low] | [latches] [resets] [ENTER]

>
```

3 Command Reference

Fast Code

To facilitate interface to software control of the PALC, the text auto-completion reply that is useful for human interaction may be inhibited.

To use the Fast Code mode, send a hash '#' character first before the characters required to construct the command. A '#' received as the first character instructs PALC to silently decode the command until a line terminator is received. The command is then processed and carried out. The PALC returns "OK" as the acknowledgment. If the command cannot be processed, the position of the error character is reported.

Example: Set the sampling rate to 2Hz:

```
Sent: #setisa2<LF>
>OK
Sent: #setisa9<LF>
>Error: character 7
```

Explanation: First command is interpreted as "set time sample rate 2Hz.

For the second command interpretation stops at character 7, as there is no command "set time sample rate 9 . . . "

The line terminator may be a CR, LF, or CR+LF pair.

The PALC has a 127 character serial input buffer. Several commands may be sent in series, they will be held in a receive buffer and sequentially carried out. Start each command with a hash (#) and end with a line feed <LF>

The characters of each command are identified in the following command tables rightmost column.

Show Commands

Configurations and Status

Syntax		Fast Code
show	channels	#shch
	controllers	#shco
	logger data	#shl
	status	#shs

Description:

- Channels: Configuration of channel as functions of input and output types.
- Controllers: Controllers assignments of inputs monitored and outputs controlled.
- Logger Data: Dumps all logger data. Press any key to interrupt.
- Status: Show status of many things.

Set Commands

Channels

Syntax			Fast Code
set	channel	enable	(0 - 7) #sece(0 - 7)
		disable	(0 - 7) #secd(0 - 7)
		config	(0 - 7) #secc(0 - 7)

Description:

- Enable: The channel data will print in a data column and be logged to memory.
- Disable: The channel data will not be available.
- Config: Enter the configuration menu for the channel.

Channels 0 to 5 A/D Configuration Sub-Menu

Syntax		Fast Code
analog		#a
analog multiplier	(value)	#a[CR](value)
digital	input	#di
	output	#do
show		#s
exit		#e

Description:

- analog: The channel becomes a 10-bit analog input.
- analog multiplier: The analog result is multiplied by this value. Example, setting this value to 5 will result in a full scale output of 5110 corresponding to an input of 5.11 Volts.
- digital input / digital output: Set as digital input or output.
- show: Show the channel configuration.
- exit: Exit this channel menu. Settings are saved.

Channel 3, 4, 5 Encoder Configuration Sub-Menu

Syntax		Fast Code	
encoder		#en	
set	tics/quadrature	2	#set2
		4	#set4
	MAX count	(value)	#sem[CR](value)
	index source	MAX count	#seim
EXT D/A/EI 5 input		#seie	
reset		#r	

Description:

- encoder: Configure channels 3 and 4 to be encoder inputs A and B. This overrides the previous channel functions. The other encoder menu options are shown only if channel 3 is configured as encoder input.
- tics/quadrature: When set to 2, the encoder counter clocks on each rising and falling edge of encoder input A (4 D/A/EA). When set to 4, the encoder counter clocks on each rising and falling edge of both encoder input A (4 D/A/EA) and input B (3 D/A/EB).
- MAX count: Value at which the encoder counter is set to by an underflow and reset by an overflow.
- index source:
 - MAX count: The encoder counter is set to this value by an underflow, and the counter is cleared by an overflow at this value. To synchronize the counter to the encoder zero position, send a reset.
 - EXT 5 D/A/EI: Channel 5 will be configured as the external index input to the encoder. This overrides the previous channel function. The encoder counter is cleared or preset to MAX count by a signal at this input. See the Encoder External Index Timing below.
- Reset: clear the encoder counter.

Encoder External Index Timing Diagrams

Application of the External Index Input (Channel 5 D/A/I)

An external signal from the encoder hardware may be used to synchronize the encoder to the zero position, rather than the internal count limit MAX count.

When the encoder is traveling in the count-up direction, the count is reset by a rising edge on the Index input. Without a rising edge on the Index input, the encoder counter will not rollover until 65536.

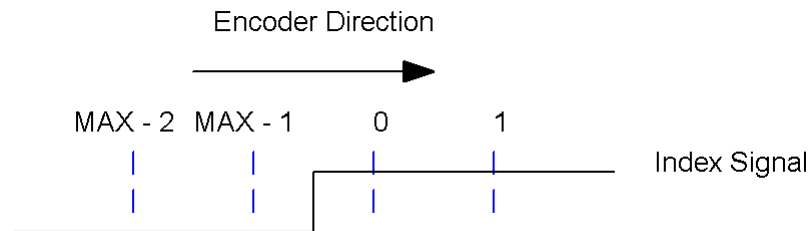

When the encoder is traveling in the count-down direction, the count is set to MAX count by a falling edge on the Index input. Without a falling edge on the Index input, the counter will be preset to 65535 on underflow.

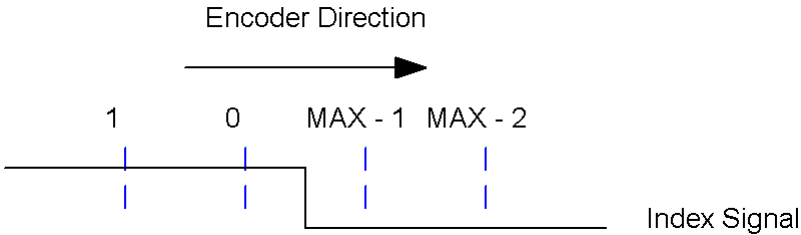

If the encoder is expected to function in both directions, then a pulse must be applied between the MAX count and zero positions. The pulse will accommodate both conditions above. The positive Index pulse shown.

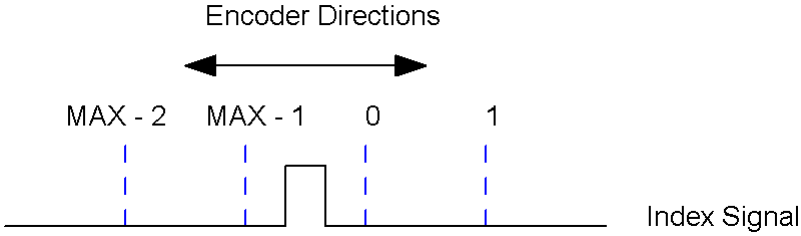

The negative Index pulse.

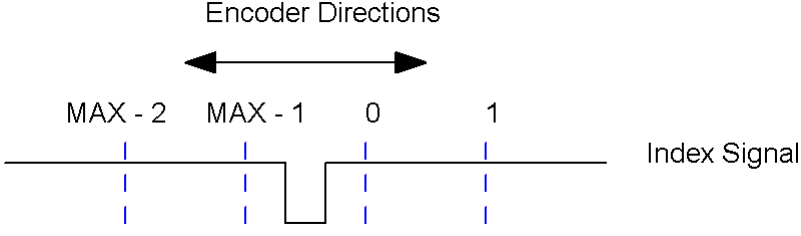

Channel 6 RPM Configuration Sub-Menu

Syntax		Fast Code
RPM		#r
rotor poles	(1 - 8)	#r(1 - 8)
digital	input	#di
	output	#do
show		#s
exit		#e

Description:

- RPM: Configure channel as digital pulse input calibrated to measure RPM (60/T(sec)). This input is overridden if trigger mode is set to external trigger source. See page 17.
- rotor poles: Sensors for rotating machines can have multiple output pulses per revolution. Setting this value divides the input rate to provide a true RPM reading.
- digital: See Channels 0 to 5 A/D Configuration Menu

Channel 7 Counter Configuration Sub-Menu

Syntax		Fast Code
frequency		#f
count		#c
digital	input	#di
	output	#do
show		#s
exit		#e

Description:

- frequency: Configure channel as digital pulse input to measure frequency in Hertz.
- count: Configure channel as digital pulse counter input.
- digital: See Channels 0 to 5 A/D Configuration Menu.

Timing Functions

Syntax				Fast Code	
set	time	clock	(dialog)	#setic[CR]HH[CR]MM[CR]SS	
		scheduled run	start	(dialog)	#setiscs[CR]HH[CR]MM
			duration		#setiscd[CR]HH[CR]MM
			repeat		#setiscr[CR]HH[CR]MM
		sample rate	1Hz	#setisa1h	
2Hz	#setisa2h				
5Hz	#setisa5h				
10Hz	#setisa10				
20Hz	#setisa20				
30Hz	#setisa3				
50Hz	#setisa50				
60Hz	#setisa6				
	min:sec (dialog)	#setisam[CR]MM[CR]SS			
sleep delay	(dialog)	#setisl[CR]SS			

Description:

- clock: Set the 24 hour time clock. The PALC M4 model keeps time during power-down.
- scheduled run: All settings for scheduled run are HOURS:MINUTES. Start, duration, and repeat may be set from 1 minute to 23 hours, 59 minutes. However the duration time must be less than the repeat time or an error will be issued.
 - start: Scheduled start time. When the clock time advances past the start time, the duration will automatically be added to calculate the next start time. This update to keep the start time in the future occurs even if not in any run mode. This allows the currently running scheduled run to be stopped and restarted without having to reprogram the next start time.
 - duration: Run time length. If duration is set to 00:00, then one acquisition cycle will happen and the PALC will go to sleep until the next scheduled run.
 - repeat: Repeat interval. If repeat is set to 00:00, then one scheduled run for the set duration will happen. The PALC will not repeat.
- sample rate: Time base tick rate. Two ranges: 1 Hz and faster; and once per second to once per 10 minutes, 59 seconds.
- sleep delay: Automatic power-down seconds. Set to zero to disable sleep mode.

Trigger Modes

Sampling is triggered by time base, three external modes, or RS-232 command. The external trigger mode “set trigger source sync edge” will sample once to several times per external trigger event, as set by burst samples. The burst sampling rate is the time base rate.

Syntax						Fast Code	
set	trigger	source	internal timebase			#setri	
			EXT 6 D/RPM	async	rising	#setrsear	
					falling	#setrseaf	
				sync	edge	rising	#setrsesr
						falling	#setrsesf
			level	high	#setrsesh		
				low	#setrsesl		
			burst samples (<i>applies only to “sync edge” mode</i>)			(value)	#setrb[CR] (value)

Description

- internal timebase: Continuously sample at the internal time base rate.
- EXT 6 D/RPM: Configures this channel to be external trigger input.
 - async: Sample immediately, is not synchronized to the internal time base.
 - sync: Sample acquisition is delayed to be synchronized with internal time base.
 - edge: A rising / falling edge presets a sample on the next time base tick. Will sample for specified burst samples at the time base tick rate. Additional trigger events during burst sampling will be ignored.
 - level: A logic level high / low on the external trigger input during a time base tick will trigger a sample. Will sample continuously at the time base tick rate while logic level is maintained.
- burst samples: Acquires this number of samples when triggered. Applies only to EXT sync edge.

Trigger Modes Timing Diagrams

Trigger Mode Examples

The following diagrams show the three trigger modes: internal time base, external modes, and manual trigger. Asynchronous “async” modes sample immediately. Synchronous “sync” modes delay sampling until the next time base tick.

Sampling once every time base click.

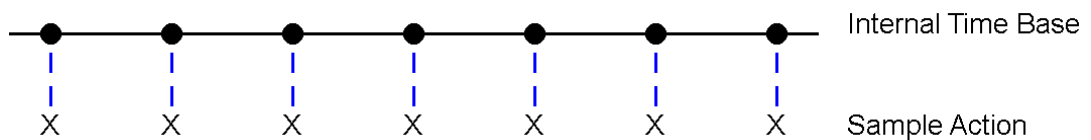

“set trigger source internal”

Sampling immediately on external trigger, once per time tick allowed. A snapshot of a changing input is taken independently of the time base tick. Only one sample per time click period is taken. Choosing the time base rate low pass filters the trigger input.

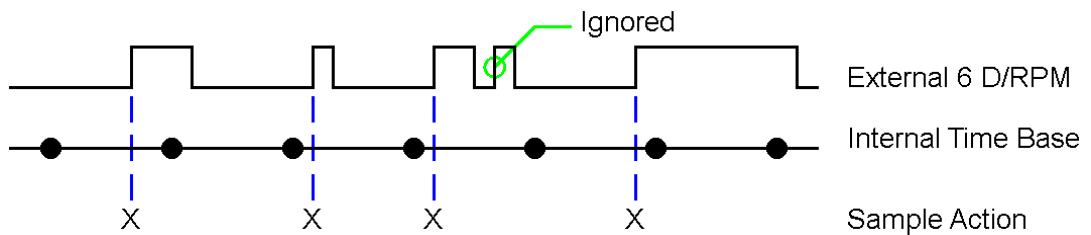

“set trigger source external 6 D/RPM async rising”

Continuous sampling while the external trigger input is a logic high level. Sampling is synchronized with the time base.

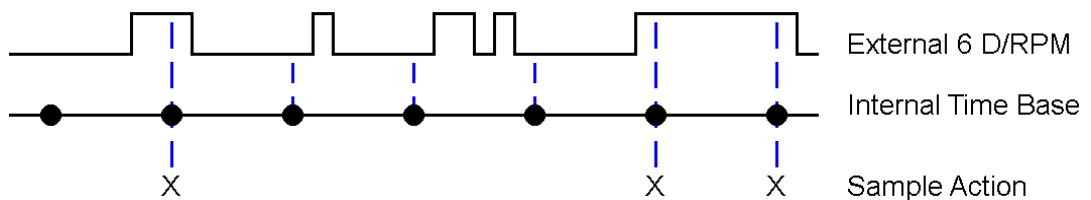

“set trigger source external 6 D/RPM sync level high”

Sampling on rising edge of trigger input. Sampling is synchronized with the time base.

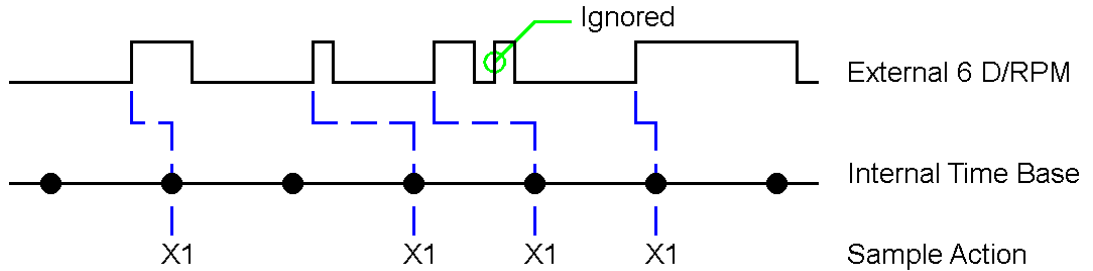

Burst samples = 1

“set trigger source external 6 D/RPM sync edge rising”

Sampling on rising edge of trigger input. Sampling is synchronized with the time base. This mode will not re-trigger until the sample burst has completed.

Burst samples = 3

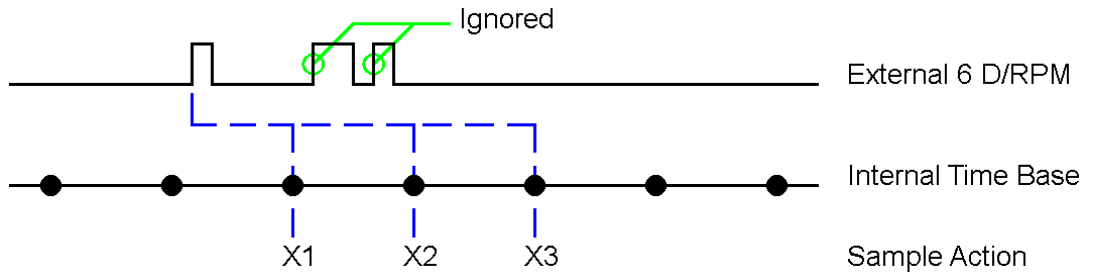

“set trigger source external 6 D/RPM sync edge rising”

Sampling by serial command via RS-232.

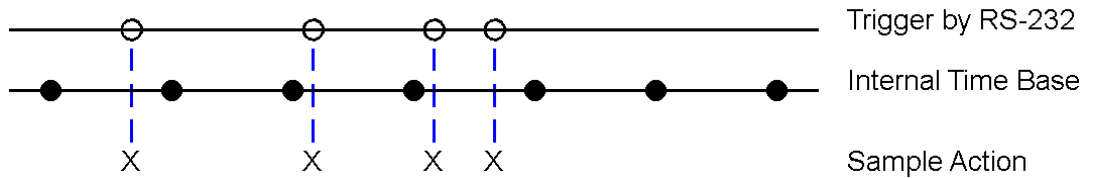

“trigger”

Print Formatting

Syntax			Fast Code	
set	print	index	clock time	#sepic
			timebase ticks	#sepit
			sample count	#sepis
			disabled	#sepid
		header	on	#sephon
			off	#sephof
		scrolling	on	#sepson
			off	#sepsof

Description:

- index: Specify the time axis metric. The first column of the data line.
 - clock time: Hours, Minutes, Seconds, Decimal.
 - timebase clicks: Integer counting of the timebase ticks.
 - sample count: Integer counting of sample counts. This is different from timebase ticks in the external trigger modes.
 - no time axis scale printed in data output.
- header: Turn on or off printing of the data header. Data header consists of one line of trigger mode information followed by the channel configuration column header.
- scrolling: Turn on or off upward scrolling of the data line. Turning off scrolling removes the line-feed character, but sends the carriage return character .

Data Logging

Syntax			Fast Code
set	logger	enable	#sele
		disable	#seld
	mode	restart	#selmr
		append data	#selma

Description

- enable: enable logging
- disable: disable logging
- mode:
 - restart: Each new “run” data-set overwrites all previous data in memory.
 - append: Each new “run” data-set is appended to last data-set in memory.

Logging stops when logger memory is full. However data sampling continues.

Controllers

Syntax			Fast Code
set	controller	enable	[0 - 5] #sese[0 - 5]
		disable	[0 - 5] #sesd[0 - 5]
		config	[0 - 5] #sesc[0 - 5]

Description

config: Begin a dialog to fill in the following sentence:

“For input X greater-than-equal / less-than the value Y sets output Z high / low latches /resets”

- resets: For an output set by a true input condition, if the input condition is removed the output resets to the original state on the next sample acquisition.
- latches: For an output set by a true input condition, the output will not reset but remains set permanently. The output may be reset by another controller which also controls the same output, except to reverse the output state. The output may also be reset via serial port with an “output” command.

Operate Commands

Output

Syntax		Fast Code
output	high	#oh(0 - 7, p)
	low	#ol(0 - 7, p)

Description

- output: sets to logic high or logic low a channel configured as an output (0 - 7). Opens or closes the P SWITCH (power switch to ground). Setting P SWITCH low turns on the internal MOSFET and connects the same named terminal to ground. Setting P SWITCH high turns off the MOSFET and the P SWITCH terminal becomes high-impedance.

Run

Syntax		Fast Code
run	now	#rn
	auto	#ra
	scheduled	#rs

Description

- now: Begin sampling based on trigger mode. Controllers and logging operate if enabled.
- auto: Same as “run now”, also the run state saved in non-volatile memory. If power is removed and restored, run will automatically resume. NOTE: If the power is removed while logging data, the end of memory position will not be saved. In addition, if logging is configured in the “restart data” mode, memory will be overwritten and lost when power is restored. If logging data and using “run auto”, and if battery power may be lost, it is recommended to set logger mode to append. In this way power may be restored, run action can be stopped, and it is probable that memory will be intact.
- scheduled: Run at the time and for the duration of the Scheduled run settings.

Trigger

Syntax		Fast Code
trigger		#t

Description

- trigger: Do a sample action immediately.

Zero

Syntax		Fast Code
zero	sample count	#zs
	event count	#ze

Description

- sample count: Zero the time axis sample counter. See [Print Formatting](#), “set print index”.
- event count: Zero the channel 7 event counter. See [Channel 7 Counter Configuration Menu](#), “count”.

4 Configuration Notes

Automatic Reconfiguration of Inputs

1. Channels D/RPM and 7 D/FREQ will be automatically reconfigured to digital inputs if the trigger mode is set to external or if a “trigger” command via RS-232 is received in the following cases. If channel 6 is configured as the RPM input, it will be changed to a digital input. If channel 7 is configured as a frequency input, it will be changed to a digital input. Channels 6 and 7 cannot be configured as RPM and frequency pulse inputs while trigger mode is external. The frequency and RPM measurements require sampling by the periodic time timebase to operate.
2. Channels 6 D/RPM and 7 D/FREQ are logic level I/O only. They each have a 1 Meg-ohm pull-down resistors on the inputs. Channels 0 through 5 with analog input capability do not. If channels 0 through 5 are configured as digital inputs and are electrically floating, excessive current flow may result, reducing battery life. Configure channels 0 through 5 as either an analog input or digital output if not electrically tied to a logic level.

Controller Setup Tips

Hysteresis. To implement hysteresis, use two controllers configured to use the same input and output. Set the lower set-point to clear (or set) and latch an output if input is less than/equal a lower limit value. Set the higher set-point to set (or clear) and latch the same output if input is greater than a higher limit value.

Conflicting Set-points. Warning. Configuring a controller to trip if the input is greater than a low value, combined with another controller to trip and reverse the same output when the same input is less than/equal a higher value will cause the output to toggle back and forth on each measurement cycle when the input is between the two set-points. Evaluation of the second set-point will reverse the first.

Using RPM for Fast Sample Rates

Resolution for RPM and Frequency are highest at sample rates of 1 second or slower. As sampling rate is increased, frequency measurements begin to skip digits. To measure low frequencies at fast sample rates, try using the RPM input with "poles" set to 6. Frequency resolution will be 0.1 Hz at the 1 Hz sample rate, while sub-Hz resolution still is available at multi-Hz sample rates. This is because the pulse input period is mathematically inverted to calculate frequency for RPM. $\text{Frequency} = 1/T$.

Input Noise

Mechanical switches. When using mechanical switches with any digital input including RPM, Count, and Frequency, it is recommended to parallel connect a capacitor across the switch to reduce the effects of contact bounce. The value depends on the resistor used to apply current to the switch, and may need to be experimentally determined. Values of 0.1uF to 10uF are recommended. Observe polarity when using electrolytic capacitors.

Long leads to analog inputs. When connecting analog sensors to analog inputs with long wires, noise can be picked up by the wires which can result in erratic measurements. A capacitor of 0.01uF to 10uF may be connected between the analog input and ground to shunt noise to ground and provide source charge for the analog input. If the channel is configured as an output the capacitor should be removed.

Input protection. Do not exceed the maximum (-0.3 V to 6.0 V) voltage on any input or damage may occur. Terminals are protected from destructive voltages including static discharge by a circuit which clamps excess input voltages to a safe level. The clamping begins at approximately 6V and is rated 200mA for each input or all inputs combined. Applying higher voltages with high current capacity may exceed the input protection and damage the PALC.

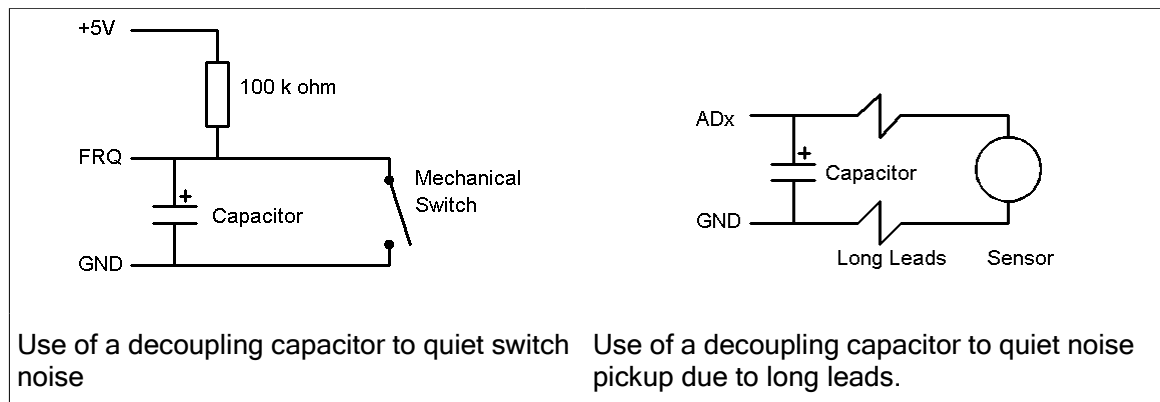

Battery Types

Alkaline, NIMH, NlCAd, or Carbon-zinc batteries all work well. When driving LED's or other loads, carbon-zinc cells may not be recommended due to the expected higher current drain. Using the MOSFET switch (P SWITCH) to switch externally powered loads has no effect on battery life. Rechargeable batteries are economical when driving external loads with total current approaching 100mA. While NIMH and NlCAd provide excellent service life for active use, these types tend to self-discharge in a matter of months. In applications in which the unit will spend a long time in sleep mode, alkaline cells are recommended.

5 Specifications

Sleep States

Output	State During Sleep Mode	State Following Wake-up
5.12V reference out	OFF	ON
Channels as digital outputs	High Impedance	All outputs set LOW
MOSFET Power Switch	OFF, High Impedance	OFF, High Impedance

Electrical

Parameter	Specification
All Inputs	Max. Input Voltage: -0.3 V to 6.0 V Max. Input Current: 200mA any single input and total all inputs combined
A/D converter inputs	Range: 0 - 5.12 Volts. Resolution: 10 bits (5.0 mV/bit). Accuracy: ± 10 mV Programmable software multiplier: 1 to 64
Encoder	Counter Rollover Range: 1 - 65535 Index Modes: A) Automatic set/reset to MAX/0 B) external synchronization by external signal
RPM input	Speed: 60 - 65535 RPM (for sample period 1 sec) Interface: 5 volt logic level input. Programmable software divider: 1 to 8
Frequency/Event Counter input	Frequency: 0 - 30 kHz Counter Clock Edge: High to Low Interface: 5 volt logic level input.
Digital outputs	CMOS output levels, typically can source 5 mA @ 3.5 V, sink 7 mA @ 1.5 V
Digital inputs (ST)	Schmidt Trigger Logic low: < 1.0 V Logic high: > 4.1 V
Digital inputs (TTL)	TTL Logic low: < 0.8 V Logic high: > 2.1 V
MOSFET Power Switch	Max. current: 2.0 A switched to GND, open drain Max. open circuit voltage: 30 V, transient protected. On resistance: 0.06 ohms.

Parameter	Specification
Sample Rate	Fast rates: 1 Hz, 2 Hz, 5 Hz, 10 Hz, 20 Hz, 30 Hz, 50 Hz, 60 Hz Long periods: 00:01 to 10:59 min:sec
Voltage Reference Output	Voltage: 5.12 V \pm 0.5% Current: 100 mA Other: Linear regulated. 0.3 ohm output switch.
Communication	RS-232 57,600 baud, 1 stop bit, no parity, no handshaking. ASCII text.
Data Format	Data Output: Text row. Time (HH:MM:SS) or sample count (NNNNNN) column optional, followed by 0 to 8 columns of data. Delimiter is space. Output data terminator: CR+LF or CR only, Input data terminator: CR+LF, CR, LF (auto-detected).
Memory Capacity	65,472 maximum data samples. Decreases slightly if data is appended.
Indicator LED	Color: green. Indicates sample action. A test pin near the LED provides a 2 V pulse during a sample. This may be used to signal external instruments of the sampling event.
Input Supply Voltage	2 V to 4.5 V maximum. Supplied by 2 size AA cells.
Low Battery Indication	For battery supplied voltage < 2.0 V to 2.1 V [LOWBAT] string will be prepended to output data string.
Current Drain (all outputs unloaded, no floating digital inputs)	5 mA typical while active and driving an active RS-232 serial port. 3 mA typical while active but not driving a port (used as a controller for example). 180 uA typical in sleep.
Dimensions	4.35 x 2.2 x 1.1 (inches) 4 x 0.17 diameter mounting holes

6 Warranty

Warranty

For details of Statelogic, LLC warranty policy, go to our website at
<http://www.statalogic.com/support/warranty.html>

Sales and Technical Support

Statelogic, LLC
1900 Millrace Dr.
Ste 1
Eugene, OR 97403
<http://www.statalogic.com>